

Skriv brøken

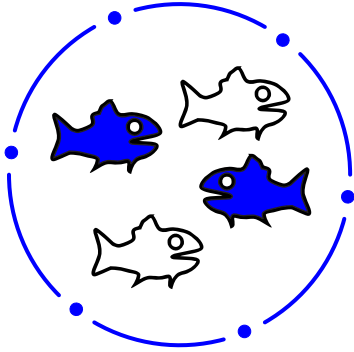

$$\frac{2}{4}$$

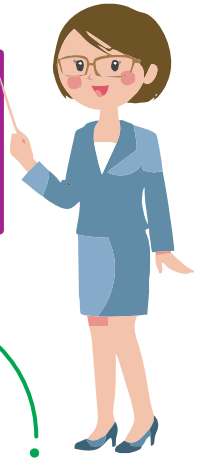
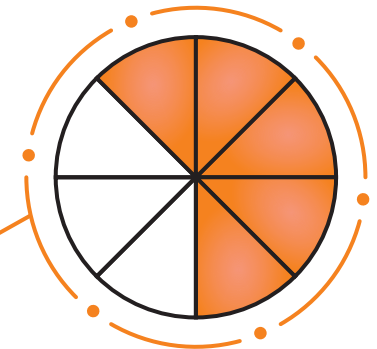
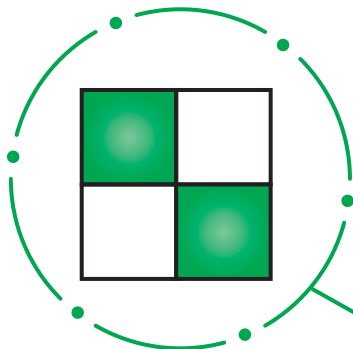
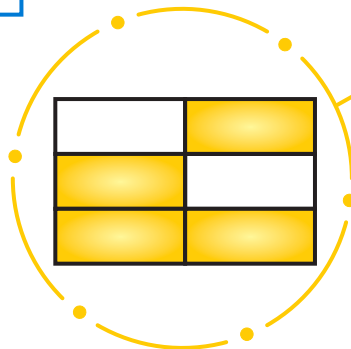
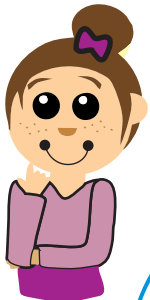
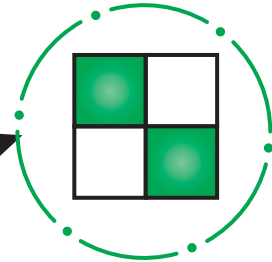

Farv brøkerne

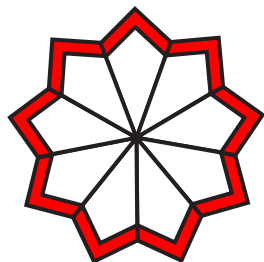

 → $\frac{7}{9}$

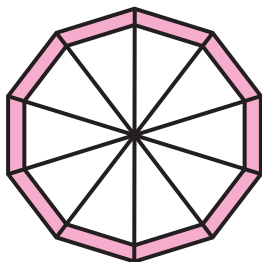

 → $\frac{3}{10}$

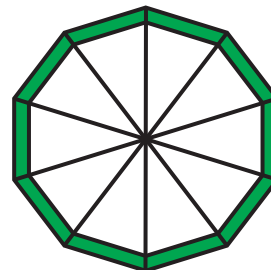

 → $\frac{5}{10}$

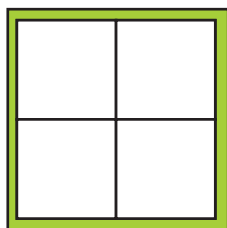

 → $\frac{2}{4}$

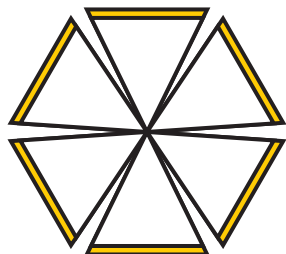

 → $\frac{5}{6}$

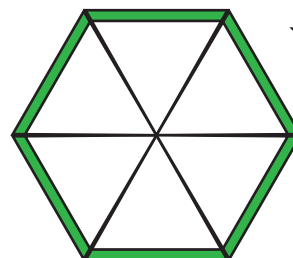

 → $\frac{2}{6}$

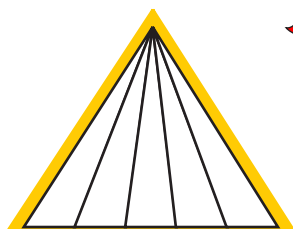

 → $\frac{1}{5}$

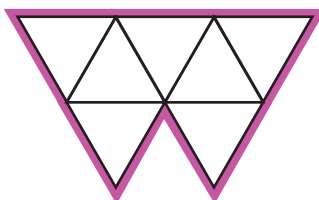

 → $\frac{4}{7}$

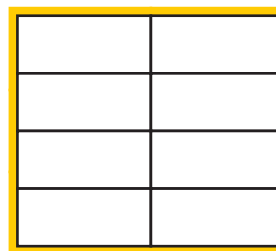

 → $\frac{5}{8}$

Brøker

Skriv den rigtige brøk.

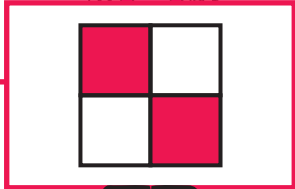
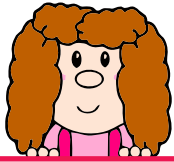

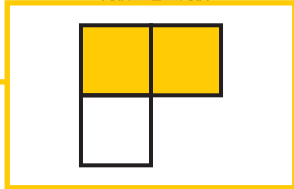

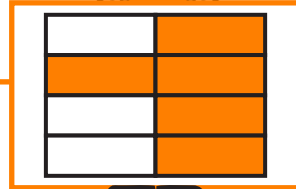
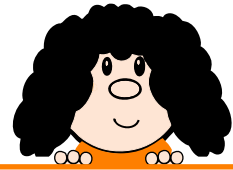





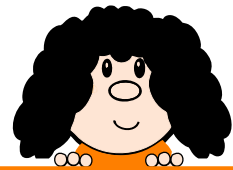

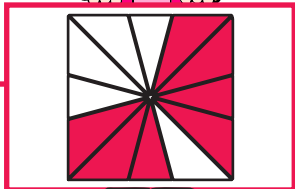

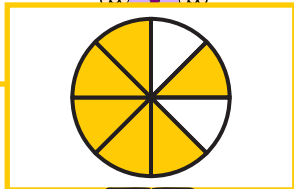



Skriv brøken

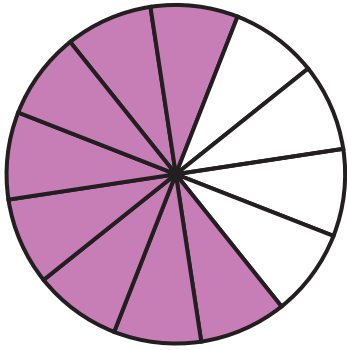

$$\frac{8}{12}$$

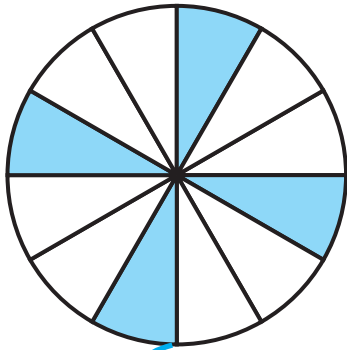

$$\frac{\quad}{\quad}$$

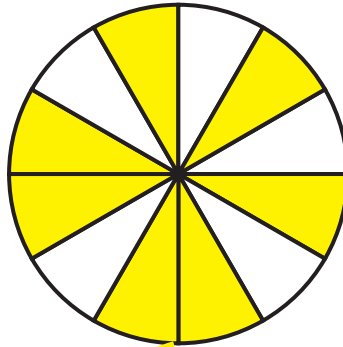

$$\frac{\quad}{\quad}$$

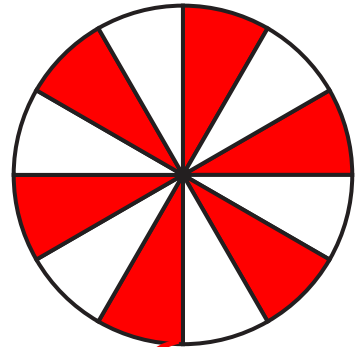

$$\frac{\quad}{\quad}$$

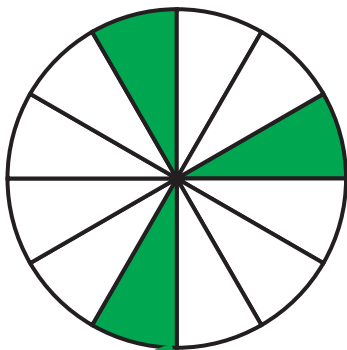

$$\frac{\quad}{\quad}$$

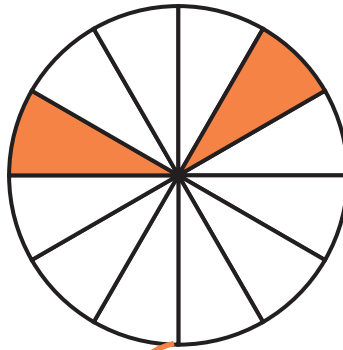

$$\frac{\quad}{\quad}$$

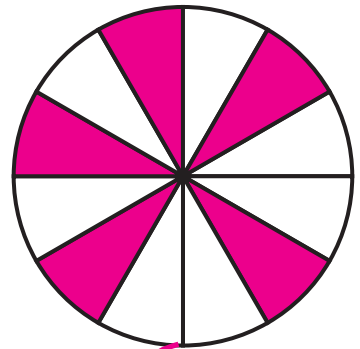

$$\frac{\quad}{\quad}$$

Farv brøkerne.

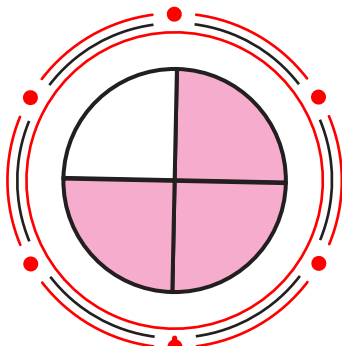

$$\frac{3}{4}$$

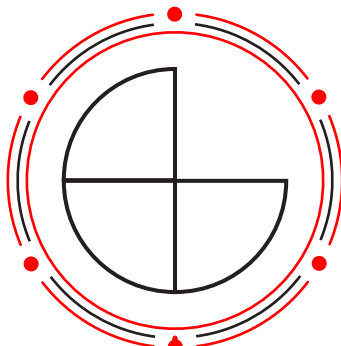

$$\frac{2}{3}$$

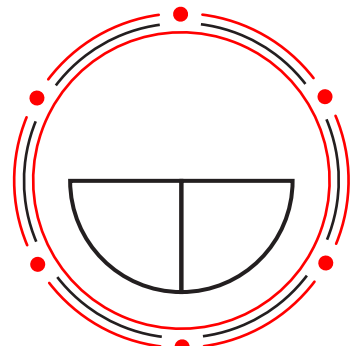

$$\frac{1}{2}$$

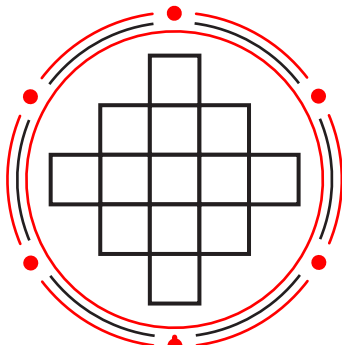

$$\frac{9}{13}$$

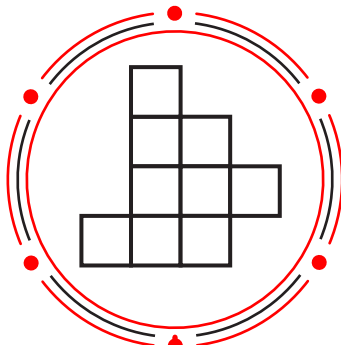

$$\frac{6}{9}$$

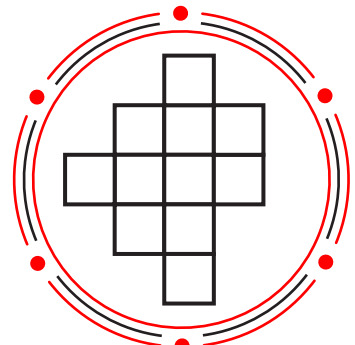

$$\frac{5}{11}$$

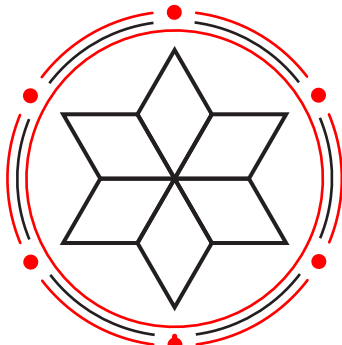

$$\frac{5}{6}$$

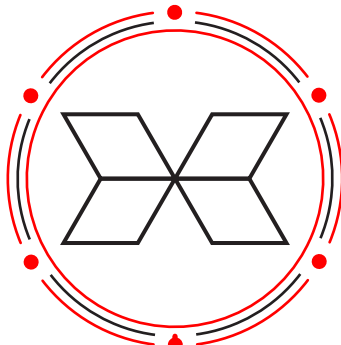

$$\frac{2}{4}$$

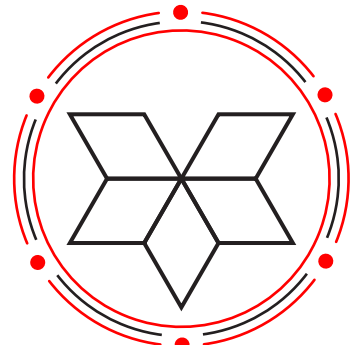

$$\frac{2}{5}$$



Plus brøker

Farv brøken og farv den som i eksemplet.

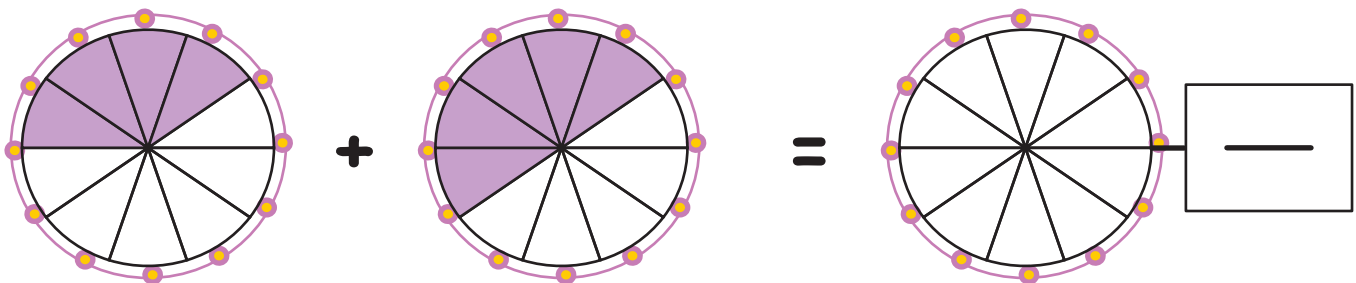
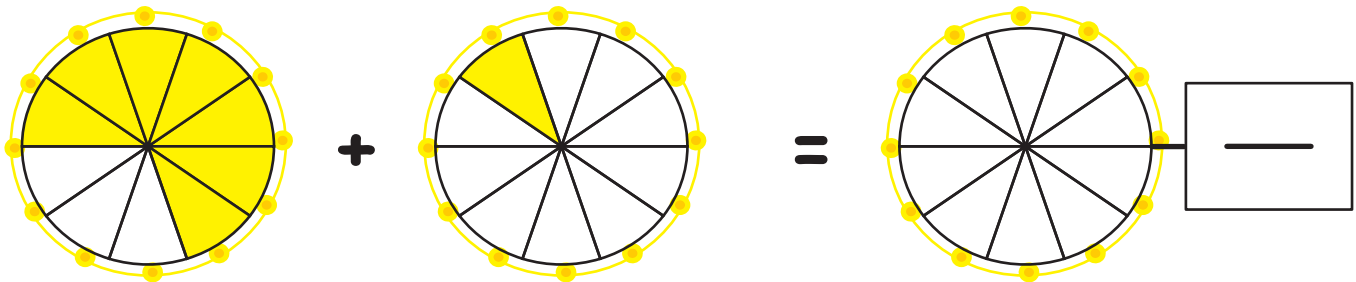
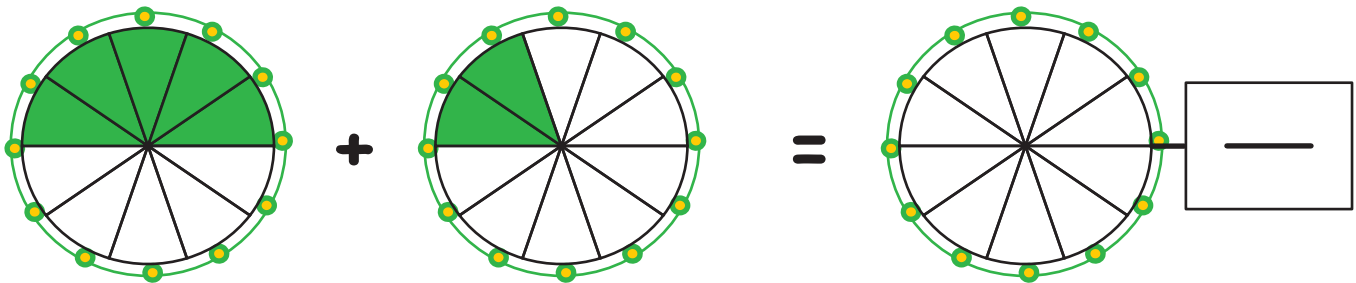
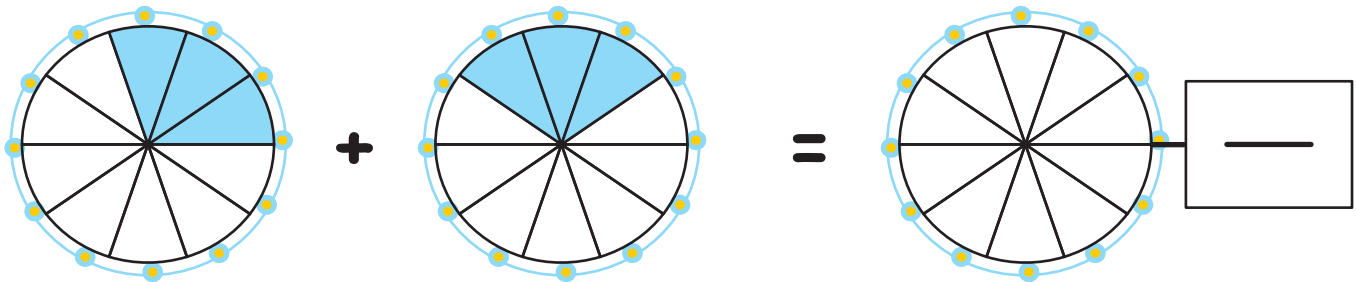
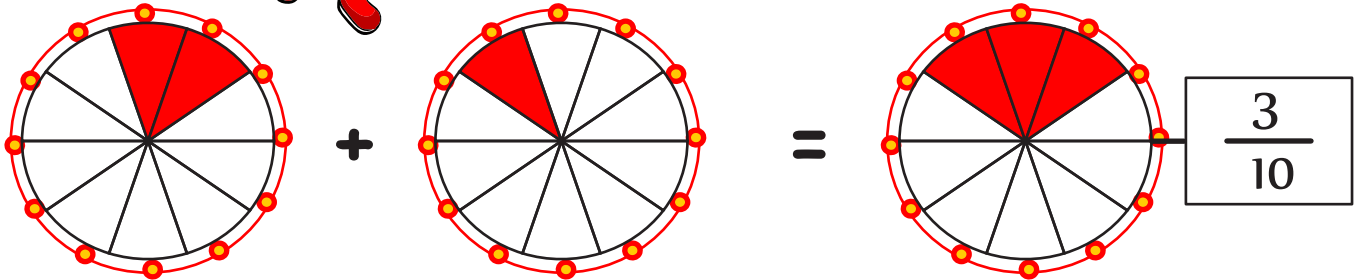

Forlæng brøker



Farv og skriv brøken.

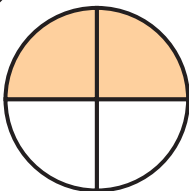

=

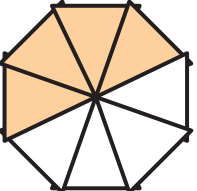

=

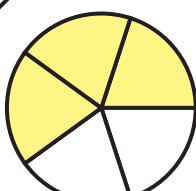
$$\frac{2}{4} = \frac{4}{8}$$

=

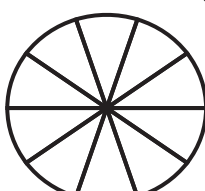

=

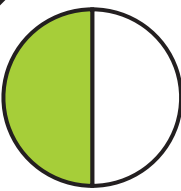
$$\frac{3}{5} = \frac{6}{10}$$

=

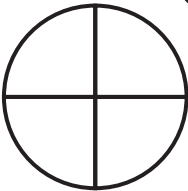

=

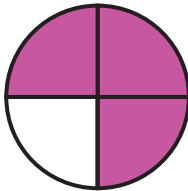
$$\frac{1}{2} = \frac{2}{4}$$

=

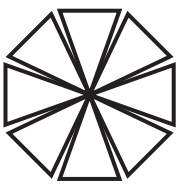

=

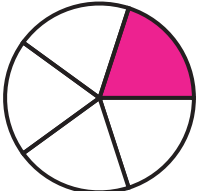
$$\frac{2}{4} = \frac{4}{8}$$

=

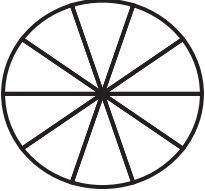

=

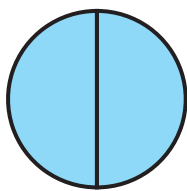
$$\frac{1}{5} = \frac{2}{10}$$

=

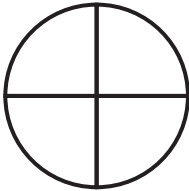

=

$$\frac{1}{2} = \frac{2}{4}$$

=

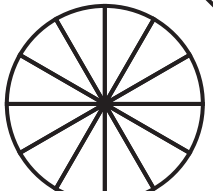

=

$$\frac{3}{6} = \frac{6}{12}$$

=

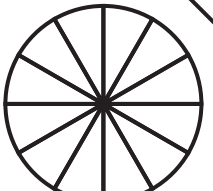

=

$$\frac{3}{6} = \frac{6}{12}$$

Brøker

Vis brøken på linien.

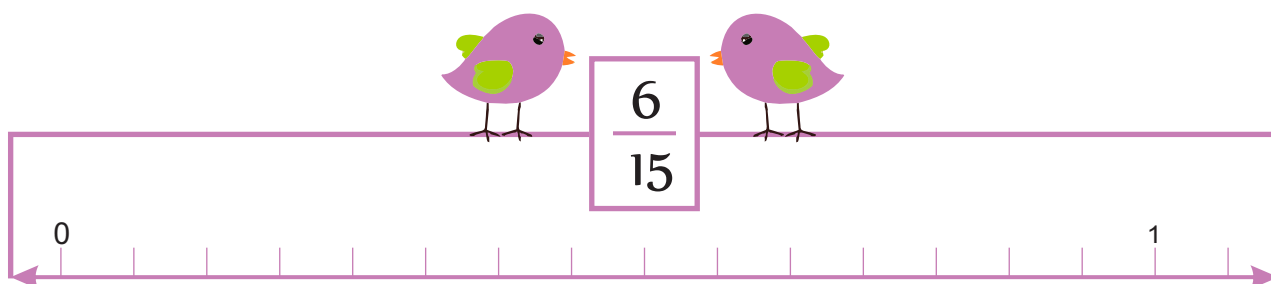
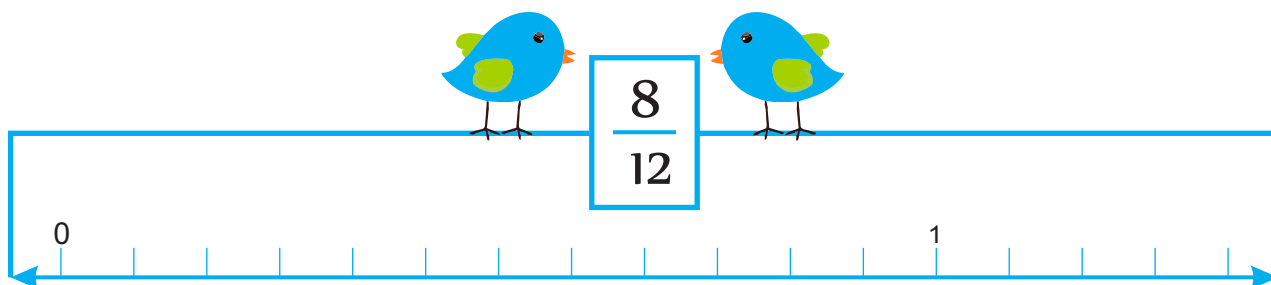
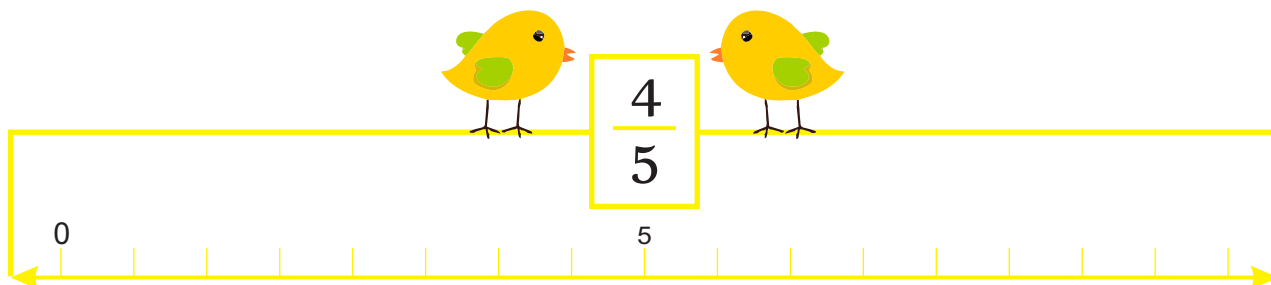
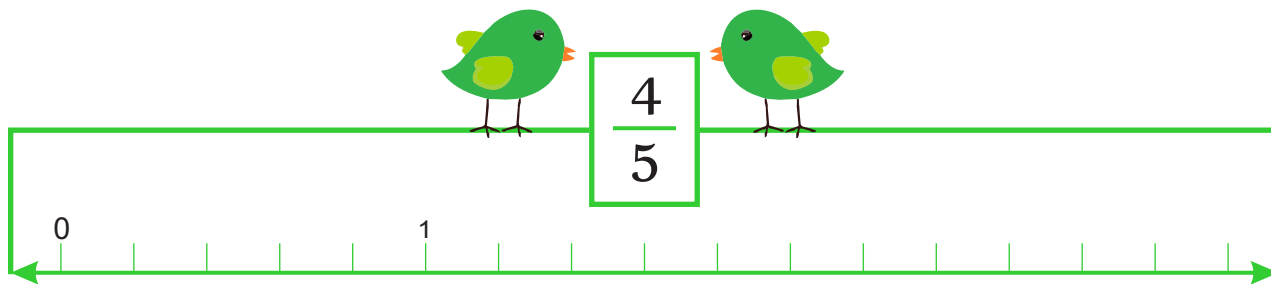
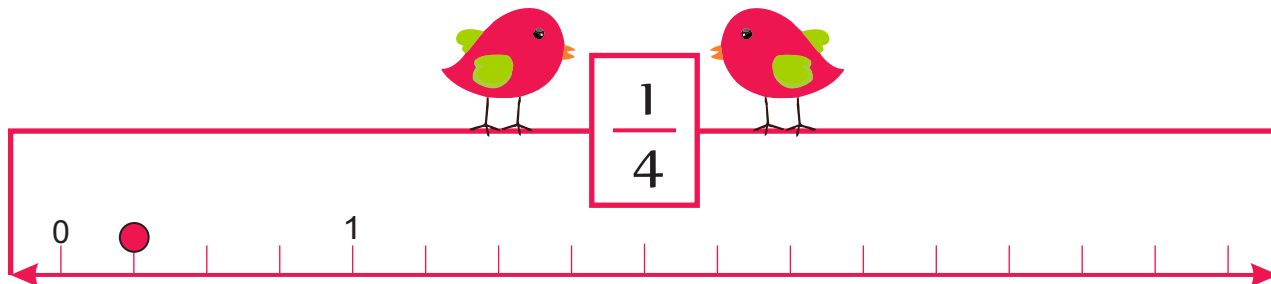

Sammenlign brøker.

Farv og brug <, >, eller = til at sammenligne brøkerne.

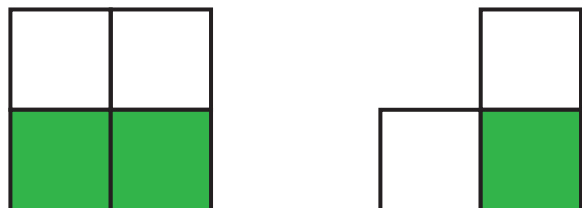

$\frac{1}{2}$



$\frac{1}{3}$

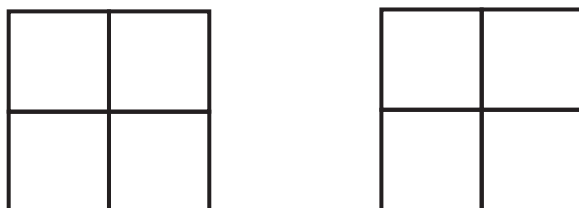

$\frac{2}{2}$



$\frac{3}{4}$

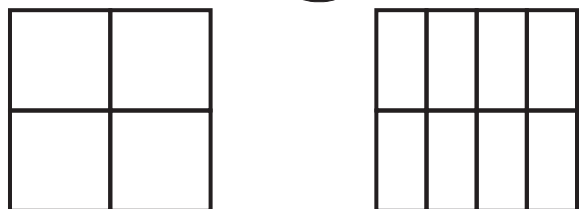
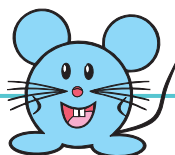

$\frac{2}{4}$



$\frac{4}{8}$

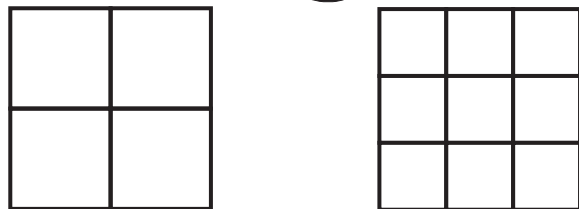
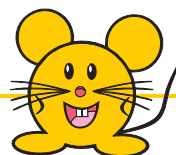

$\frac{2}{2}$



$\frac{5}{9}$

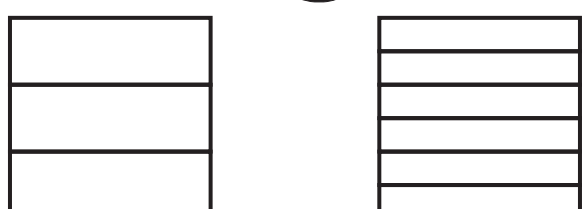

$\frac{1}{3}$



$\frac{2}{6}$

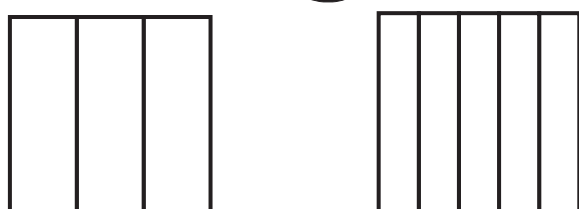
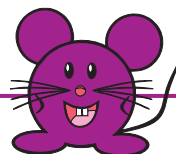

$\frac{1}{3}$



$\frac{2}{5}$

Sorter brøkerne

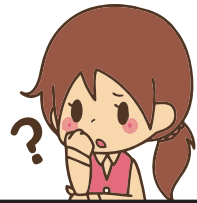
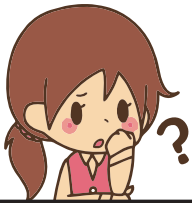

Hel	Halv	En fjerdedel	En tredjedel

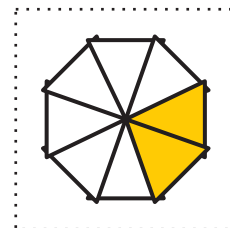
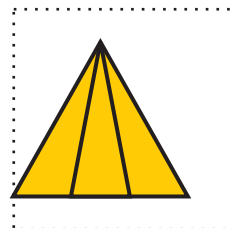
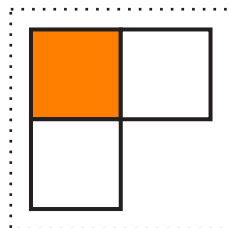
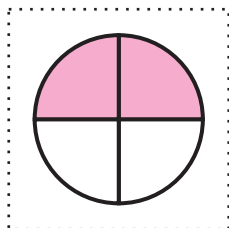
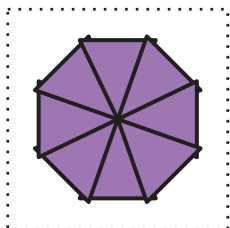
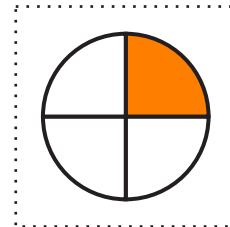
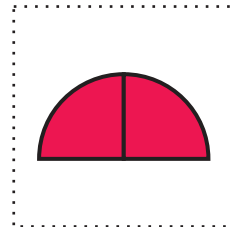
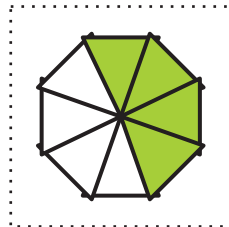
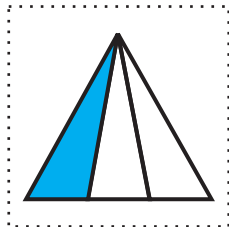
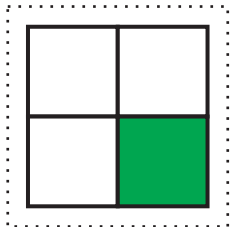

Find brøken

Sæt kryds over den rigtige brøk.



Hel Halv Kvart



Hel Halv Kvart



Hel Halv Kvart

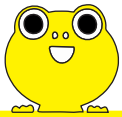

Hel Halv Kvart



Hel Halv Kvart



Hel Halv Kvart



Hel Halv Kvart



Hel Halv Kvart



Hel Halv Kvart