

Mit hæfte om nytår

Niveau 2



Navn: _____

Klasse: _____

Tegn fyrværkeri



På nytårsaften er der meget fyrværkeri. Rakter, heksehyl, knaldperler og meget andet. Hvilket fyrværkeri plejer I at fyre af i jeres familie?

- Tegn fyrværkeriet fra rakterne.



Genkend forlyden



Man plejer at tage sit pæne tøj på, når det er nytårsaftnen.
Hvilket tøj plejer du, at have på?

- Sæt ring om de to ord, der har samme forlyd.

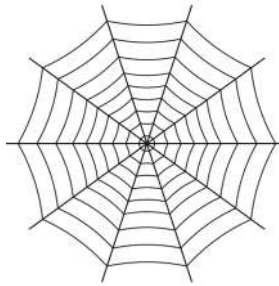

Sæt kryds



Det kan være hårdt at holde nytår. Ofte kommer man sent i seng og er sammen med familie og måske venner. Husk at man altid må gå tidligt i seng.

● Sæt kryds over det rigtige billede.

Raket



Sne



Skæg



Lyn

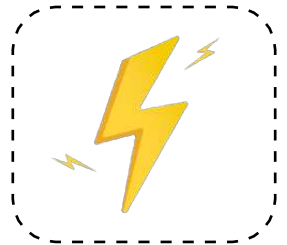
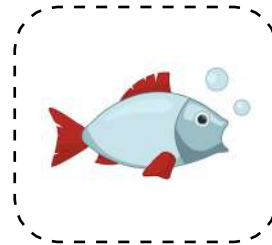
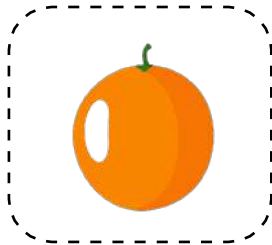

Farvelæg raketterne



Raketter kommer i mange farver og former. Nogle er rigtig store og faverige, mens andre er mindre og larmer mindre. Hvilke raketter er dine yndlings?

● Farvelæg raketterne i den rigtige farve.

gul og grøn

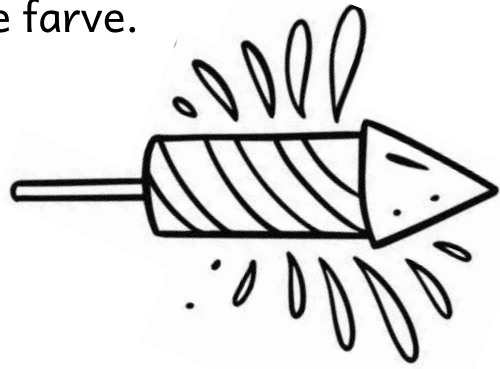

blå og rød



brun og lilla



Skriv ordet



Nytårsaften kan man også pynte op. Der kan være truthorn, hatte og andet udklædning. Har I noget udklædning hjemme ved jer?

● **Skriv ordet på linjen.**









Skriv forbogstavet



Har I nogle traditioner for nytårsdag? F.eks. en gåtur i skoven, en fodboldkamp eller spille brætspil?

- Sæt ring om ting man kan se til nytår. Skriv evt. forbogstavet.

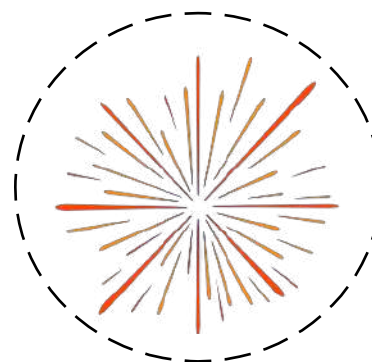

f



Skriv ordet



Betyder det noget for dig, at fejre nytår?

Hvad kan du godt lide ved nytår?

- Skriv det manglende ord på linjen.



Jeg vil have _____ på.



Må jeg få min _____?



Far spiser _____.



En _____ er gul .

Labyrint



Det er heller ikke alle som er lige vild med fyrværkeri. Nogle kan være bange, eller synes det larmer. Husk, at man altid kan se fyrværkeriet indenfor, hvis man ikke kan lide det.

- Find vej hen til hatten. Skriv bogstaverne du møder på linjen.

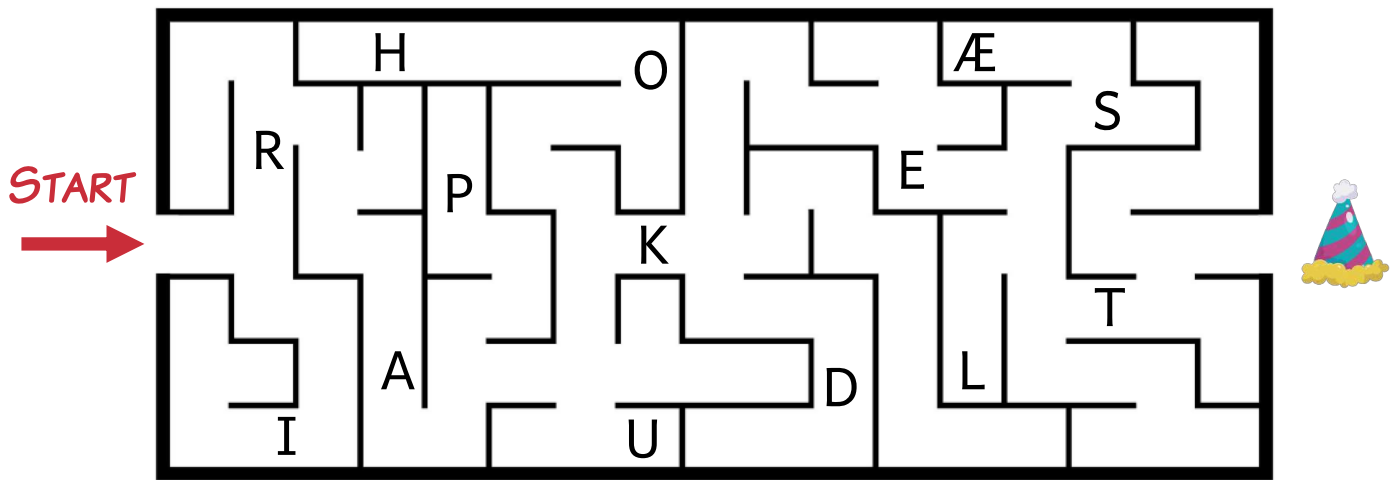

- Farvelæg billedet som passer til ordet.

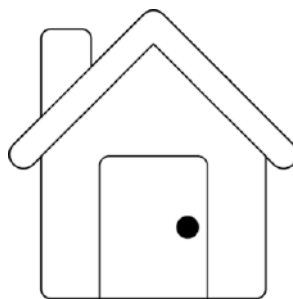
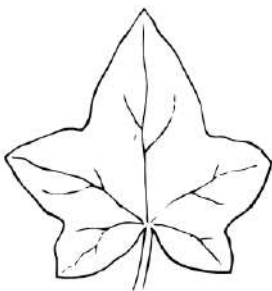

Nytårsaften



Nytårsaften fejrer man ofte med andre. Hvem skal du holde nytår med? Dine venner, familie, naboer, kæledyr eller andre?

- Tegn og skriv navnene på dem, du skal holde nytår med.

A large, empty rectangular box with a decorative border. The border consists of a thick black line with small, glowing gold and yellow stars and dots scattered along it. The interior of the box is plain white, providing space for drawing and writing names.

Skriv forbogstavet



Til nytårsaften bliver der ofte serveret god mad. Nogle får 3 retter, andre får en ret. Hvad får I at spise nytårsaften?

- Skriv forbogstavet på ordet.



_____øj



_____age



_____ys



_____il

Lav en menu



Til dessert nytårsaften får man ofte kransekage formet som et tårn.
Får I kransekage hjemme ved jer? Og kan du lide det?

- Tegn og skriv, hvad du vil spise nytårsaften.



pizza

Nytårsfortsæt



Når det bliver nytår er der mange som laver et nytårsfortsæt, som betyder at man har nogle mål man ønsker at opnå. F.eks. at blive bedre til fodbold.

● Sæt streg til det rigtige billede.

Jeg vil blive bedre til, at _____

Skrive ●



Cykle ●



Male ●



Danse ●



Vokalerne

Til midnat hvor året skifter, er der nogle som hopper ned fra stole eller sofaer. Det gør man for at "hoppe ind i det nye år".

● Sæt ring om vokalerne i ordet.



f y r v æ r k e r i

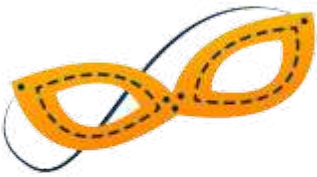

u d k l æ d n i n g



d e c e m b e r



n y t å r s t a l e