

MIT MUSIKHÆFTE



Navn: _____

Klasse: _____



MUSIK



Hvad er musik?

Skriv eller tegn her under, hvad musik er for dig.

A large, empty rectangular box with rounded corners and a dark blue border, intended for writing or drawing.



INSTRUMENTTYPER

Her ser du en masse instrumenter. Der er både fløjte, flygel, trompet, sækkepibe og mange flere.

Sæt ring og dem du kender.

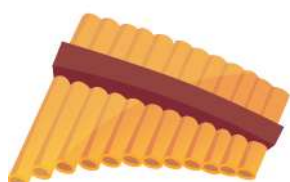

SLAGTØJ

Slagtøj er en type musikinstrument, der laver lyde, når man slår på dem eller ryster dem.

Slagtøj kan også være instrumenter som klokkespil, triangler og tamburiner.

Slagtøj er vigtigt i musikken, fordi det hjælper med at skabe rytme og energi. Når man spiller slagtøj, kan man følge musikken og hjælpe med at holde takten.

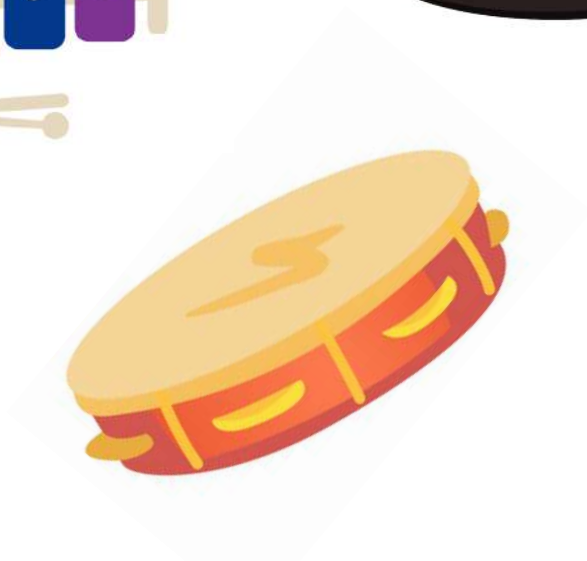
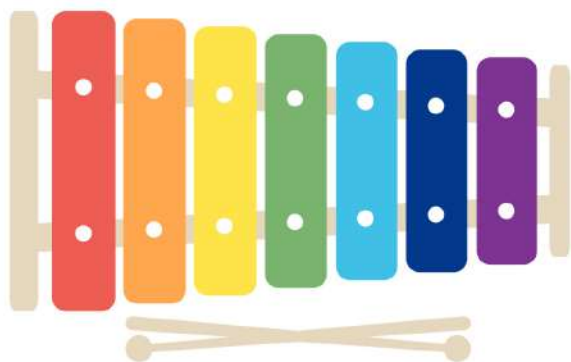

MARACAS

Maracas er et slagtøj, som oprindeligt er fra Mexico. Inde i dem er der små sten eller gryn, som får dem til at rasle, når du ryster dem.

Når du bruger instrumentet, øver du din rytmesans. Det kan faktisk være ret svært at ryste dem i en bestemt rytme.

FARVELÆG DE TO MARACAS.

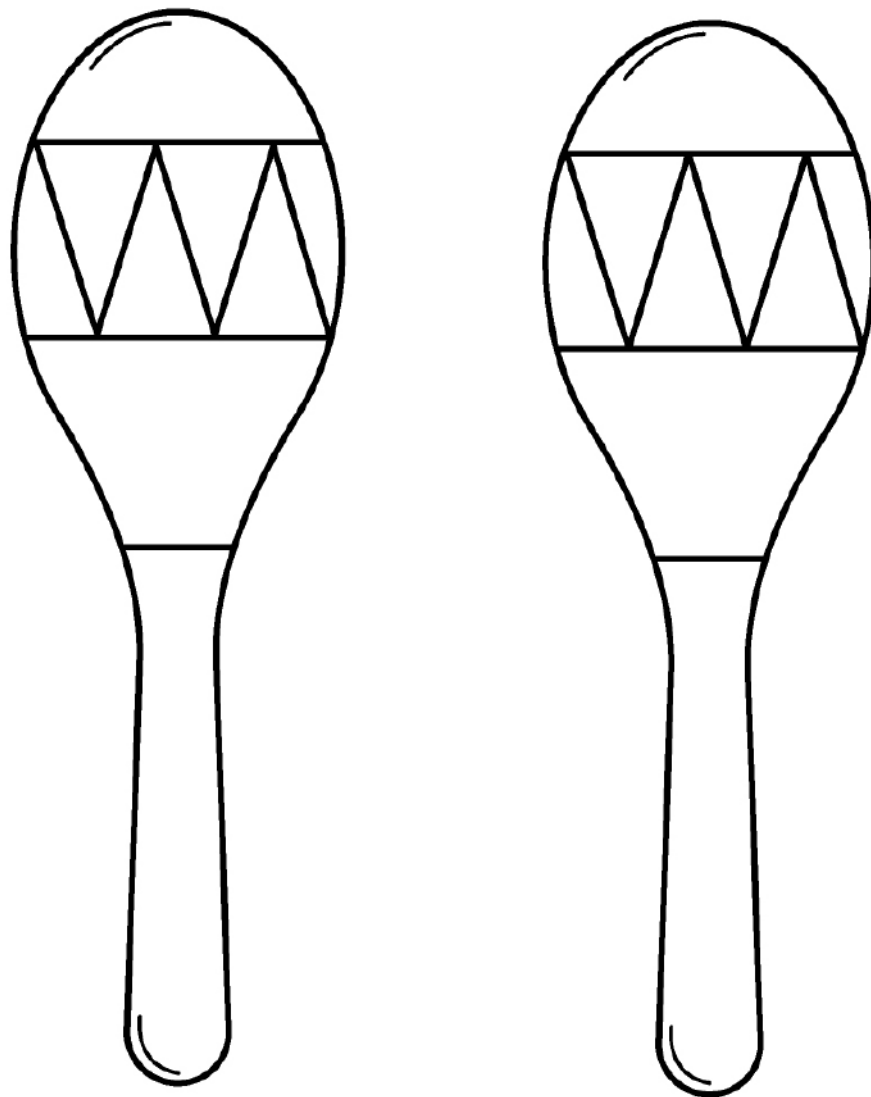

Prøv selv om du kan tromme en rytme på et bord med dine hænder.

TROMMEN

Trommen er nok et af de mest kendte instrumenter. En tromme er lavet af en cylinderformet kasse, hvor der er spændt et skind ud over kassen på den ene ende. Trommen er også et slagtøj.

Man kan både spille trommer med hænderne eller med trommestikker, som er lange pinde. Ved at slå på forskellige steder på trommen, kan man lave forskellige lyde og rytmer.

TEGN TROMMEN FÆRDIG.

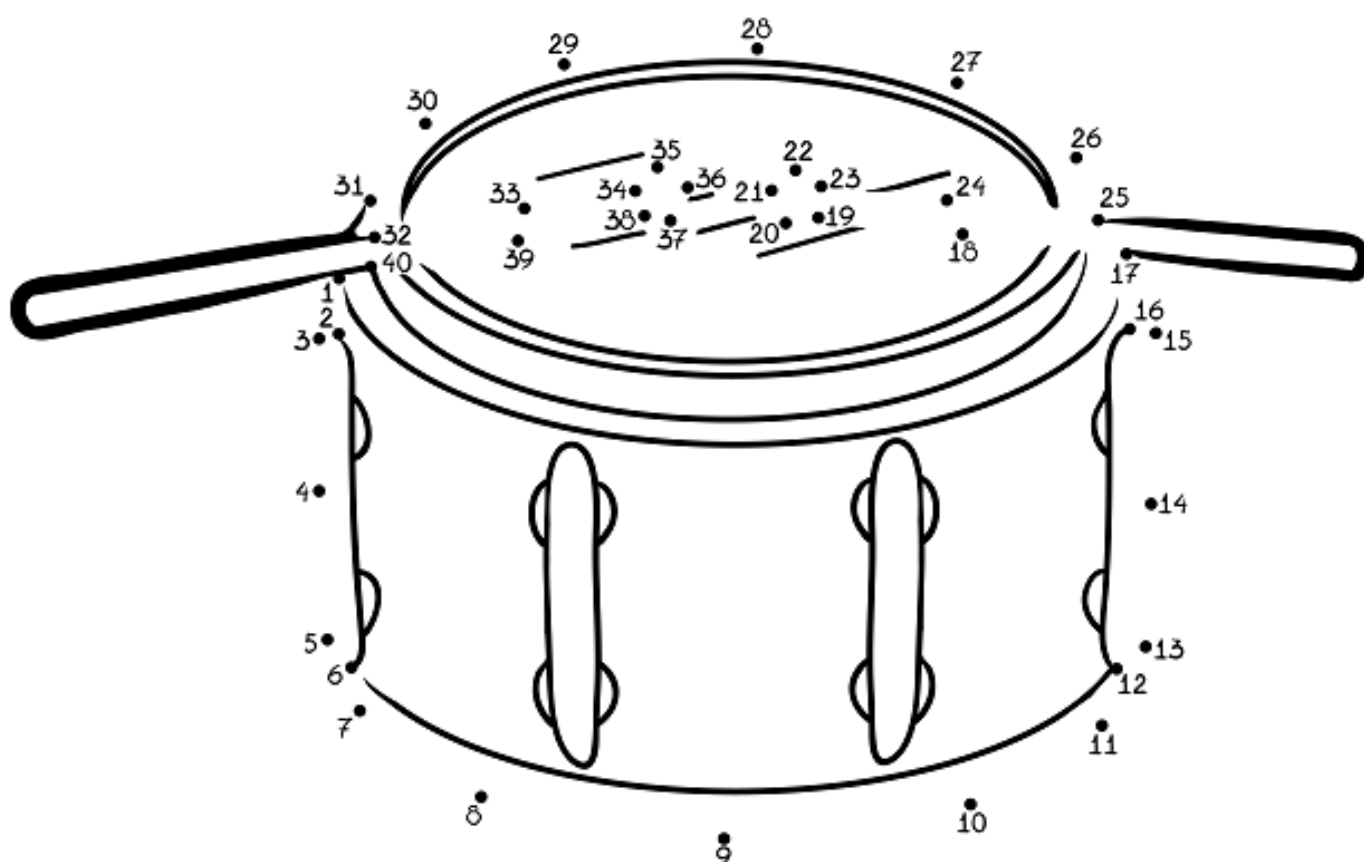

SÆT RING OM SLAGTØJ TYPER

Her ser du en masse instrumenter. Der er både fløjte, flygel, trompet, sækkepibe og mange flere.

Sæt ring om slagtojet.

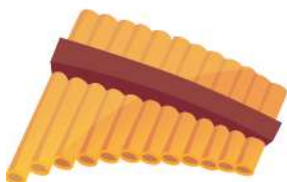
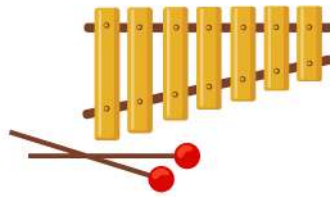

FARVELÆG

Hvilken instrumenttype er trommen?

FARVELÆG TROMMEN.

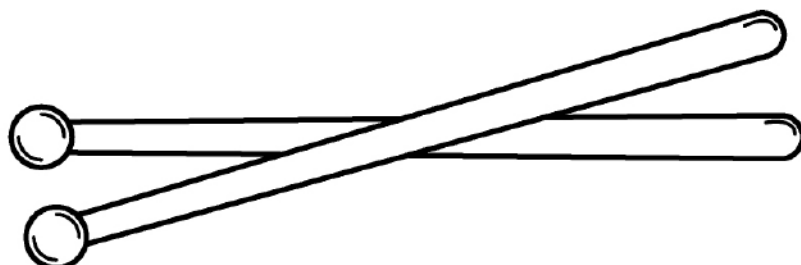
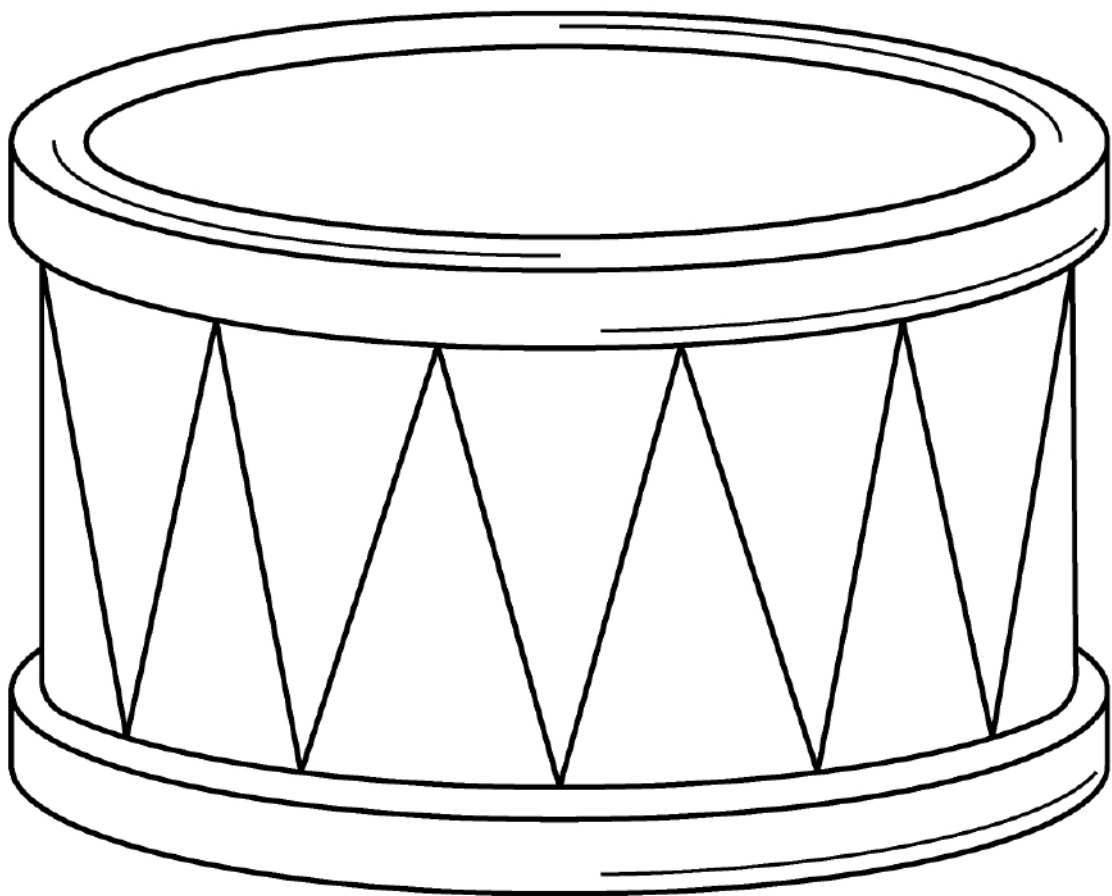

MUSIKINSTRUMENTER

Her ser du 5 instrumenter; panfløjte, xylofon, guitar, lilletromme og harmonika.

Sæt en streg fra billedet til det rigtige navn.



● Lilletromme



● Panfløjte



● Harmonika



● Xylofon



● Guitar

BLÆSEINSTRUMENTER

Blæseinstrumenter er musikinstrumenter, hvor lyden bliver skabt, når der pustes luft ind i dem.

Det er eksempelvis fløjter, klarinet, saxofon, sækkepibe og trompet.

Man kan puste luft ind med forskellige teknikker, som man kan lave mange toner og melodier med.

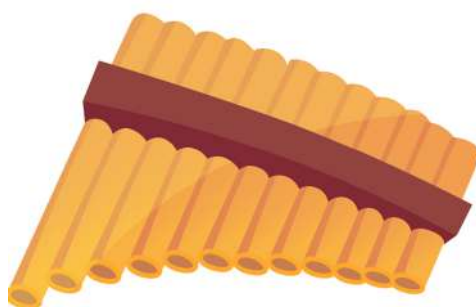

SAXOFON

En saxofon er et blæseinstrument. Det ligner et langt metalrør, som har mange knapper. Når man blæser luft ind i den og trykker på de forskellige knapper, kan man lave mange melodier.

Saxofonen har et mundstykke, hvor luften pustes ind i. Når man trykker på knapperne kan man ændre tonerne.

TEGN SAXOFONEN FÆRDIG.

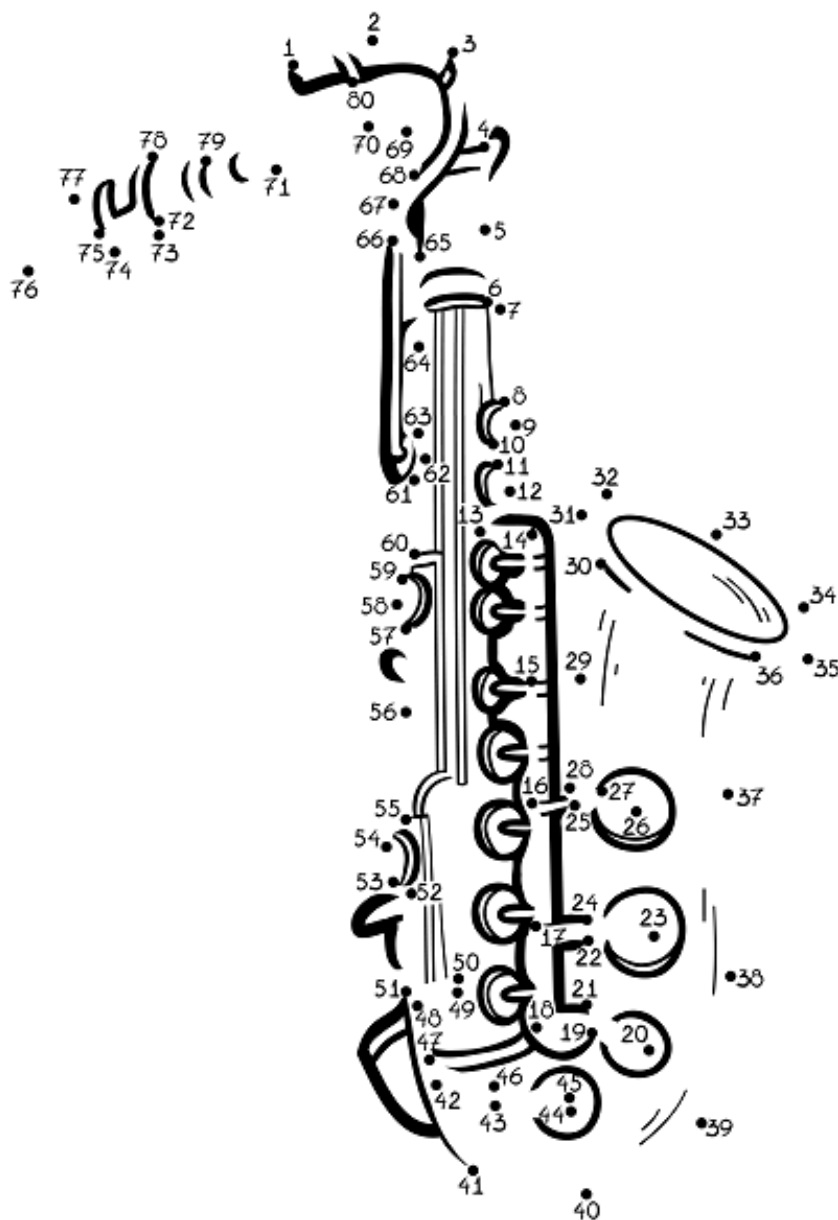

SÆT RING OM BLÆSEINSTRUMENTER

Her ser du en masse instrumenter.

Sæt ring om blæseinstrumenterne.

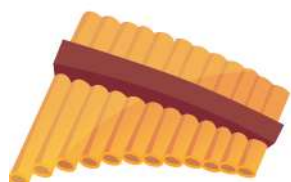

MUSIKINSTRUMENTER

Her ser du 5 instrumenter; keyboard, saxofon, mundharmonika, sækkepibe og tamburin.

Sæt en streg fra billedet til det rigtige navn.



● Mundharmonika



● Keyboard



● Saxofon



● Sækkepibe



● Tamburin

STRENGEINSTRUMENTER

Strenginstrumenter laver lyde når man stryger eller trykker på strengene. Eksempler på strenginstrumenter er guitar, violin, cello, ukulele og harpe.

Når man stryger eller trykker på strengene, kan man skabe forskellige toner og melodier.

Strenginstrumenter er vigtige, når der laves musik, fordi de er med til at skabe den stemning der er i musikken.



VIOLIN

Violinen er også et strengeinstrument, men hører til underkategorien "strygeinstrumenter". Andre strygeinstrumenter er kontrabas og cello. Violinen skulle være et svært instrument at spille på.

Når man spiller på violin, skal buen holdes i den ene hold og violinens hals i den anden. Forsigtigt stryger man buen over violinens strenge, og det laver dejlige toner.

FIND VEJEN TIL VIOLINEN.

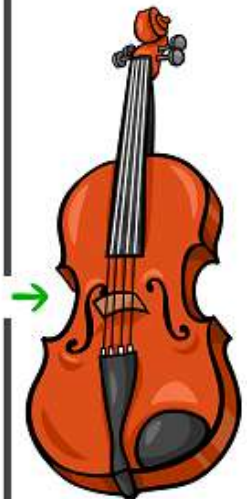
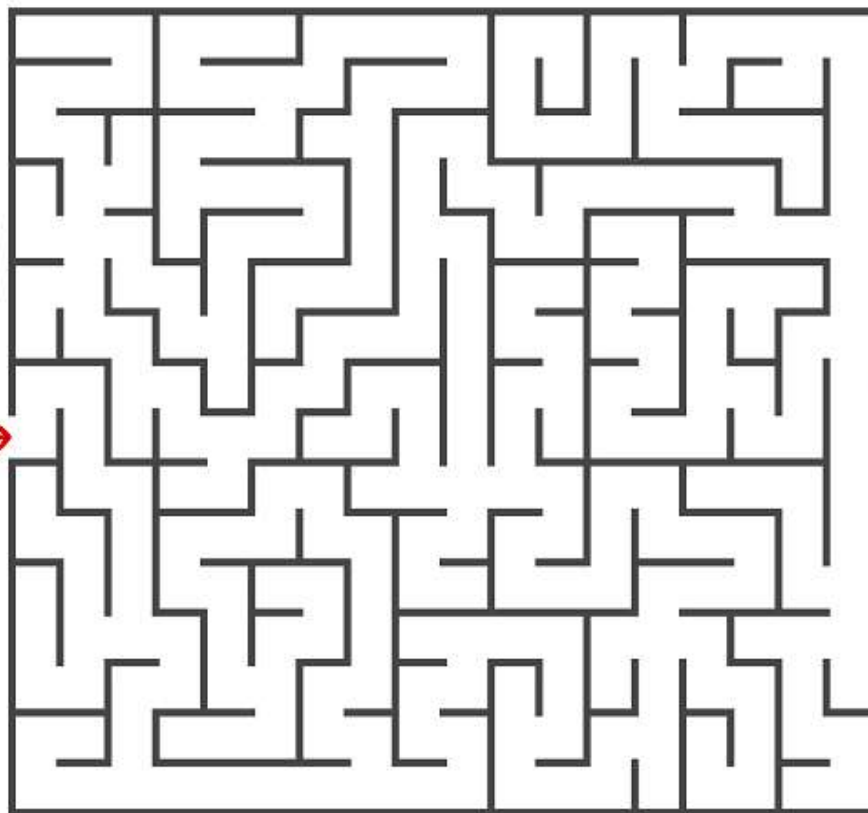

GUITAR

Guitaren er også et strengeinstrument, som laver dejlige lyde, når man rør ved strengene. Den har en flad top og en rund bagside, og ofte lavet af træ.

Guitaren har en hals, som ligner en lang stang og er forbundet med kroppen. Lige under strengene er der et hul, hvor guitaren har et stort hult rum. Det er her musikken kommer fra.

TEGN GUITAREN FÆRDIG.

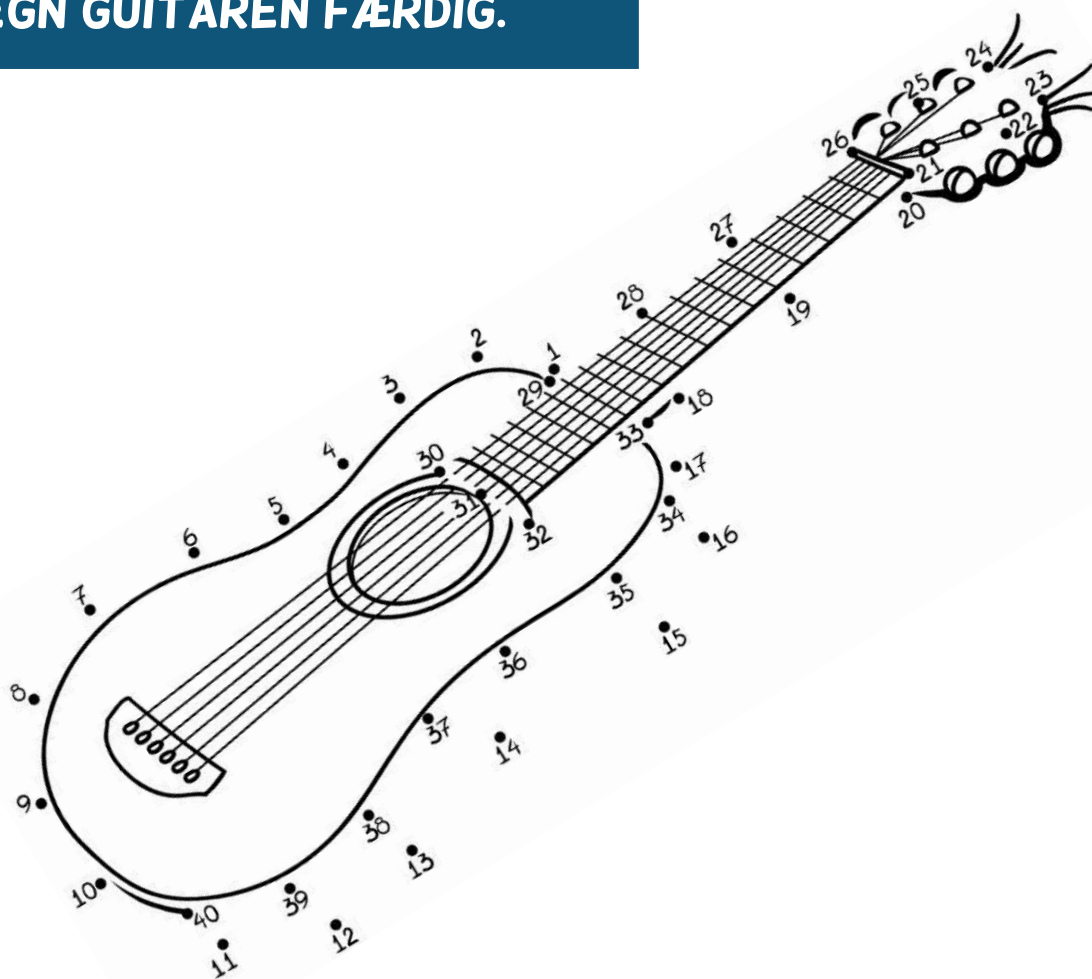

SÆT RING OM STREGEINSTRUMENTERNE

Her ser du en masse instrumenter.

Sæt ring om alle strengeinstrumenterne.

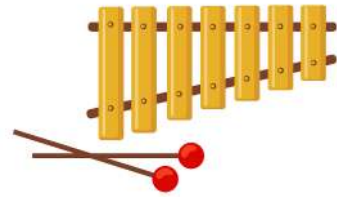

MUSIKINSTRUMENTER

Her ser du 5 instrumenter; fløjte, trommesæt, trompet, flygel og harpe.

Sæt en streg fra billedet til det rigtige navn.

Trommesæt



Fløjte



Harpe



Trompet



Flygel



TEGN EN GUITAR

Hvilken instrumenttype er guitaren?

TEGN EN GUITAR.

1.

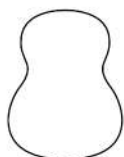

2.



3.

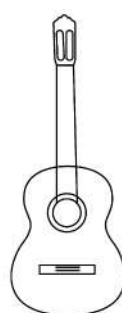

4.

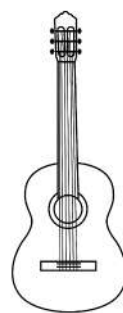

5.



NODER

Noder er som små symboler, der bruges til at skrive musik ned. Man kan nemlig ikke skrive melodier og musik ned med almindelige bogstaver.

De ligner små cirkler og streger sat sammen, som er på en linje. Noder gør at andre musikere kan læse og spille bestemte melodier og sange på deres instrumenter.



Noder er vigtige, fordi de gør, at mange kan spille det samme musikstykke på forskellige instrumenter.

SKRIV NODER

Nu skal du prøve at skrive noder. Det kan godt være lidt svært i starten, så du skal prøve nogle gange.

Skriv noder på de 3 rækker nederst.

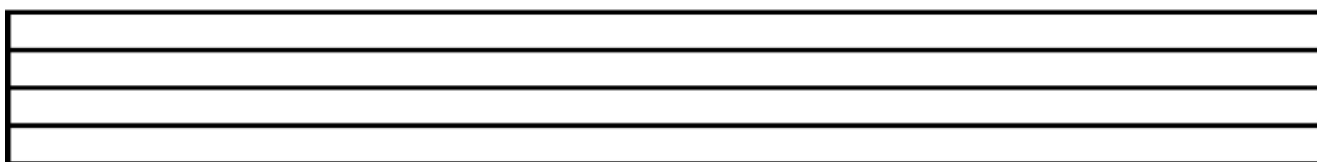
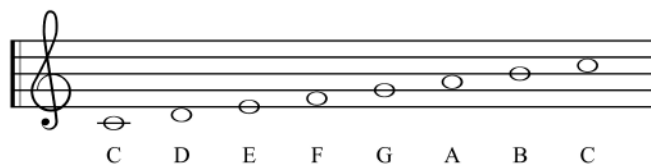

An empty musical staff with five horizontal lines.

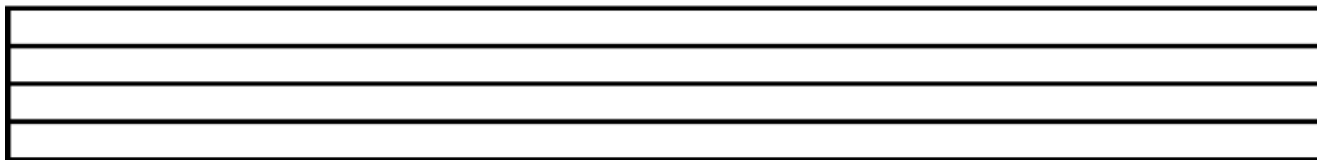

An empty musical staff with five horizontal lines.

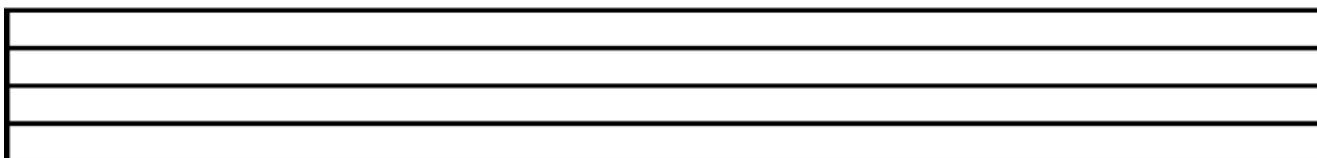

An empty musical staff with five horizontal lines.

G-NØGLE

G-nøglen har du måske set før.

Den ses ofte i sangbøger og bruges til at at fortælle noget om tonen i sangen, der skal synges.

Den er rigtig svær at skrive, prøv selv herunder.



PRØV AT SKRIVE G-NØGLEN.

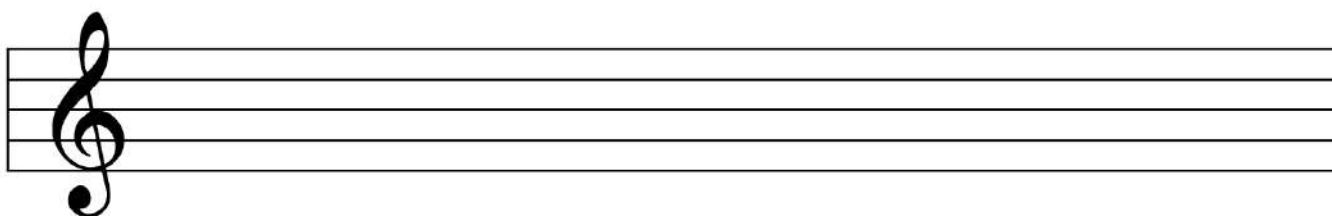
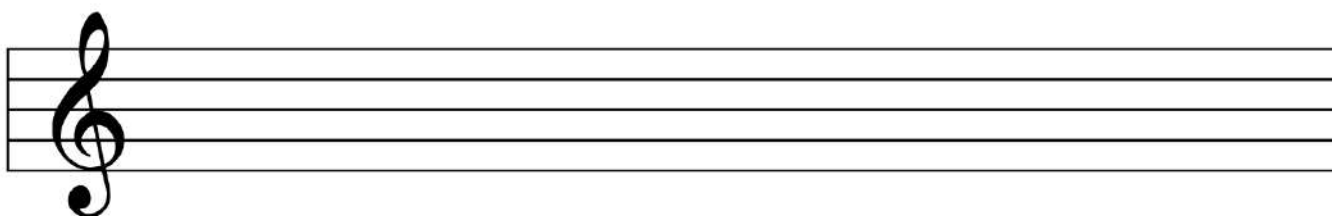
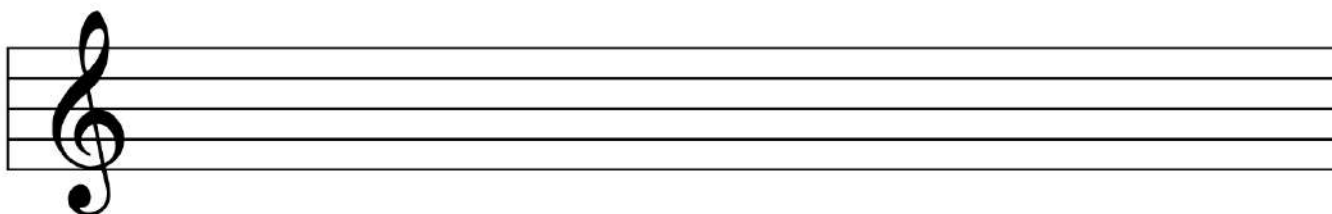
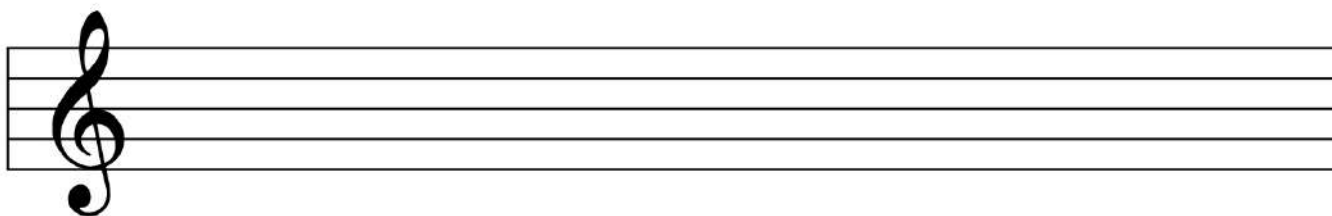

KOR

Når du synger en sang sammen med dine klassekammerater, synger du faktisk i kor. Men du kan også gå til kor, hvor du øver dig i at blive bedre til at synge sammen med andre.

Du kan gå til kor i en kirke eller på en musikskole. Mange børn og voksne synes, de bliver i godt humør af at synge sammen med andre.

FARVELÆG DE SYNGENDE BØRN.



PRØV AT TEGNE

Tegn trompeten på næste side.

1.

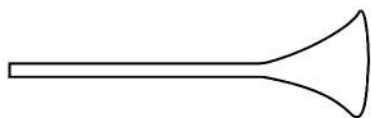

2.

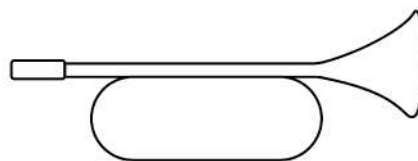

3.



4.

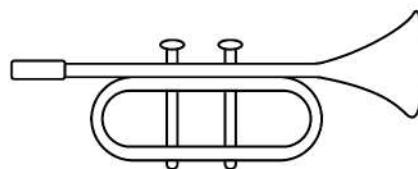

5.

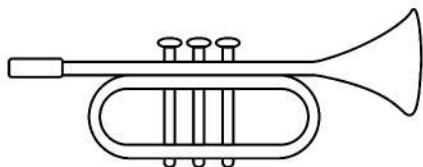

6.

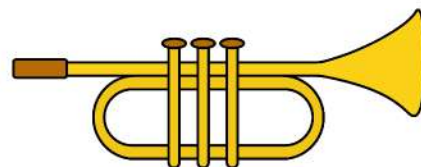

TEGN TROMPETEN